

Bestellformular isy@Store Aufsatzkasten

NP- Putzkasten / K- Klinkerkasten / WDVS- Wärmedämmverbundsystem

Telefon 02373 9883-0
Telefax 02373 9883-19



direkt per E-Mail an auftrag@mhs.de

Besteller/Firma:

Datum:

Kom.:

Lieferadresse:

gew. Liefertermin:

Behang

- Farbe(gemäß Prospekt)
- Flachlamelle 80 mm
- Standardlamelle 80mm gebördelt
- Lamelle Z-Form 90mm
- Lamelle S-Form 93mm
- Sonderlamelle

Behangführung (siehe Legende auf Seite 3)

Farbe

Seilführung → SW: Typ

Laibungsblende X X

Kastenbefestigung oben

Schachttiefe: Standard mit Lochband Montagewinkel 135 x 85 mm

Schachtfarbe: Grau (Standard) 7016 * Position des Antriebs im Kasten mittig (Standard) *

Kastentypen:

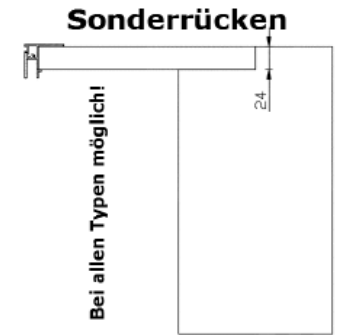
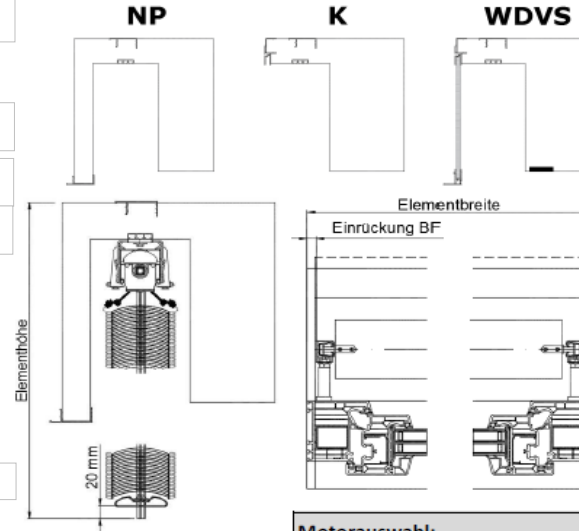

(24mm Sonderrücken ersetzt den Standardrücken *55mm* und ermöglicht eine höhere Pakethöhe)

Motorauswahl:

Somfy: elektronisch mechanisch Funk "io"

Geiger: elektronisch mechanisch + Funkreceiver

* Standard*

Funkzubehör:

Ihre Position	Stückzahl	Elementmaße in mm		isyStore Kastentyp (s.o)						Behangführung Einrückung (mind. 12 mm / Seite)		Behangführung Typ (siehe Seite 3)		ZS =Zusatzseil ***ab 2400 mm empfohlen***		Lichtleittechnik Arbeitsstellung		Behangführung Bohrung für:		90° Ecke	Kopplung / Teilung / Bemerkung		
		Elementbreite	Elementhöhe (inkl.Kasten)	Putz (NP)	Klinker (K)	WDVS*	Rücken		Tiefe / Breite	Höhe innen	Höhe außen	links	rechts	links	rechts	ZS 1	ZS 2	LT	AS			Laibung	Rahmen
							55 mm (Standard)	24 mm (Sonder)															
				<input type="checkbox"/>	<input type="checkbox"/>	<input type="checkbox"/>	<input type="checkbox"/>	<input type="checkbox"/>									<input type="checkbox"/>	<input type="checkbox"/>	<input type="checkbox"/>	<input type="checkbox"/>			
				<input type="checkbox"/>	<input type="checkbox"/>	<input type="checkbox"/>	<input type="checkbox"/>	<input type="checkbox"/>									<input type="checkbox"/>	<input type="checkbox"/>	<input type="checkbox"/>	<input type="checkbox"/>			
				<input type="checkbox"/>	<input type="checkbox"/>	<input type="checkbox"/>	<input type="checkbox"/>	<input type="checkbox"/>									<input type="checkbox"/>	<input type="checkbox"/>	<input type="checkbox"/>	<input type="checkbox"/>			
				<input type="checkbox"/>	<input type="checkbox"/>	<input type="checkbox"/>	<input type="checkbox"/>	<input type="checkbox"/>									<input type="checkbox"/>	<input type="checkbox"/>	<input type="checkbox"/>	<input type="checkbox"/>			
				<input type="checkbox"/>	<input type="checkbox"/>	<input type="checkbox"/>	<input type="checkbox"/>	<input type="checkbox"/>									<input type="checkbox"/>	<input type="checkbox"/>	<input type="checkbox"/>	<input type="checkbox"/>			
				<input type="checkbox"/>	<input type="checkbox"/>	<input type="checkbox"/>	<input type="checkbox"/>	<input type="checkbox"/>									<input type="checkbox"/>	<input type="checkbox"/>	<input type="checkbox"/>	<input type="checkbox"/>			
				<input type="checkbox"/>	<input type="checkbox"/>	<input type="checkbox"/>	<input type="checkbox"/>	<input type="checkbox"/>									<input type="checkbox"/>	<input type="checkbox"/>	<input type="checkbox"/>	<input type="checkbox"/>			
				<input type="checkbox"/>	<input type="checkbox"/>	<input type="checkbox"/>	<input type="checkbox"/>	<input type="checkbox"/>									<input type="checkbox"/>	<input type="checkbox"/>	<input type="checkbox"/>	<input type="checkbox"/>			
				<input type="checkbox"/>	<input type="checkbox"/>	<input type="checkbox"/>	<input type="checkbox"/>	<input type="checkbox"/>									<input type="checkbox"/>	<input type="checkbox"/>	<input type="checkbox"/>	<input type="checkbox"/>			
				<input type="checkbox"/>	<input type="checkbox"/>	<input type="checkbox"/>	<input type="checkbox"/>	<input type="checkbox"/>									<input type="checkbox"/>	<input type="checkbox"/>	<input type="checkbox"/>	<input type="checkbox"/>			
				<input type="checkbox"/>	<input type="checkbox"/>	<input type="checkbox"/>	<input type="checkbox"/>	<input type="checkbox"/>									<input type="checkbox"/>	<input type="checkbox"/>	<input type="checkbox"/>	<input type="checkbox"/>			

Bestellformular isy@Store Aufsatzkasten

NP- Putzkasten / K- Klinkerkasten / WDVS- Wärmedämmverbundsystem

Ihre Position	Stückzahl	Elementmaße in mm		isyStore Kastentyp (s.o)						Behangführung Einrückung (mind. 12 mm / Seite)		Behangführung Typ (siehe Seite 3)		ZS =Zusatzseil ***ab 2400 mm empfohlen***		Lichtleittechnik Arbeitsstellung		Behangführung Bohrung für:		90° Ecke	Kopplung / Teilung / Bemerkung		
		Elementbreite	Elementhöhe (inkl.Kasten)	Putz (NP)	Klinker (K)	WDVS*	Rücken		Tiefe / Breite	Höhe innen	Höhe außen	links	rechts	links	rechts	ZS 1	ZS 2	LT	AS			Laibung	Rahmen
							55 mm (Standard)	24 mm (Sonder)															
		<input type="checkbox"/> <input type="checkbox"/> <input type="checkbox"/> <input type="checkbox"/> <input type="checkbox"/> <input type="checkbox"/> <input type="checkbox"/> <input type="checkbox"/> <input type="checkbox"/> <input type="checkbox"/> <input type="checkbox"/> <input type="checkbox"/> <input type="checkbox"/> <input type="checkbox"/> <input type="checkbox"/> <input type="checkbox"/> <input type="checkbox"/> <input type="checkbox"/> <input type="checkbox"/> <input type="checkbox"/> <input type="checkbox"/>																					

Maße sind Fertigmaße, Umtausch, Änderungen oder Rücknahmen sind nicht möglich.
 Mit der Bestellung werden die z.Zt. gültigen Liefer- und Zahlungsbedingungen anerkannt, abrufbar unter <https://mha.de/agb/>

*Wärmedämmverbundsystem

Bestellformular isy@Store Aufsatzkasten

NP- Putzkasten / K- Klinkerkasten / WDVS- Wärmedämmverbundsystem

Telefon 02373 9883-0
 Telefax 02373 9883-19
 E-Mail: auftrag@mhs.de

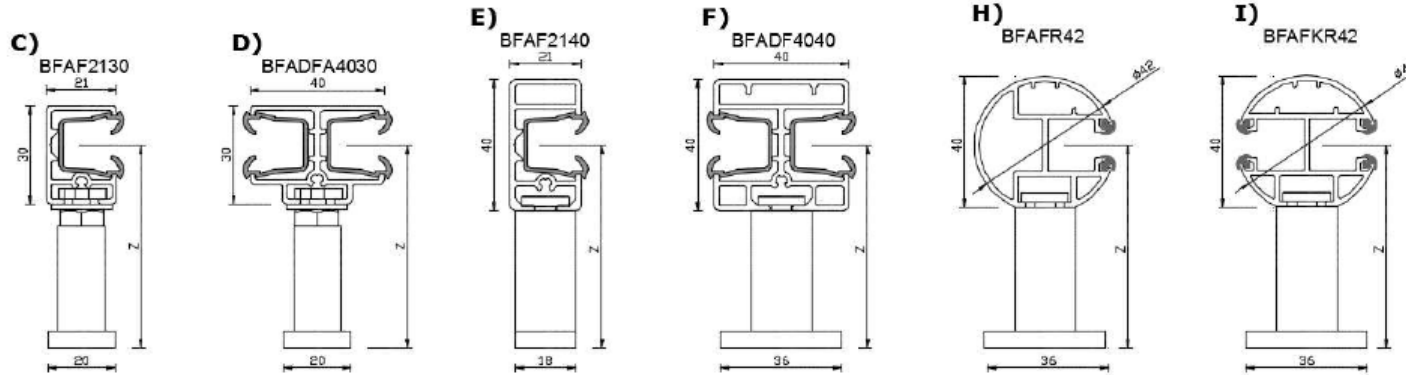

*** BAF2130 ***

Abstandhalter Variabel	
Typ	Z- Maß
A *	62-88mm
B	92-118mm
C	122-188mm
D	182-230mm

*** BAF2140 ***

Klemmkonsolen KK1, KK2	
Typ	Z- Maß
KK1 18x90	60-300mm
KK2 36x90	60-300mm

* Standard bei 140mm Schacht

*** Z- Maß individuell anzugeben ***

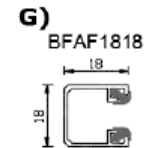
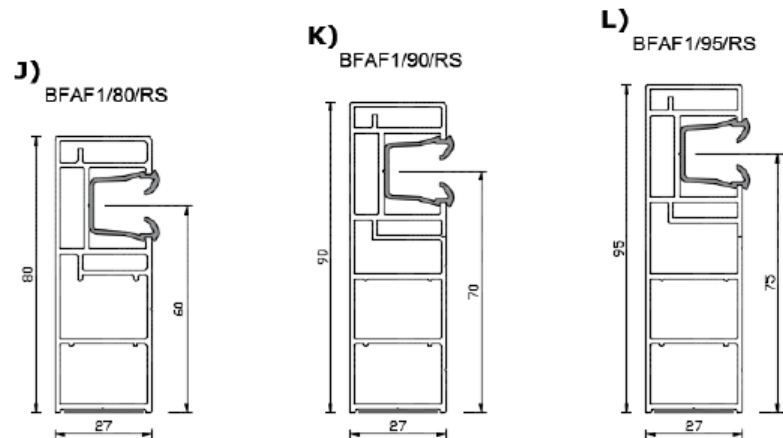

Mögliche Aufdopplungsprofile



A) BFE60/86/132

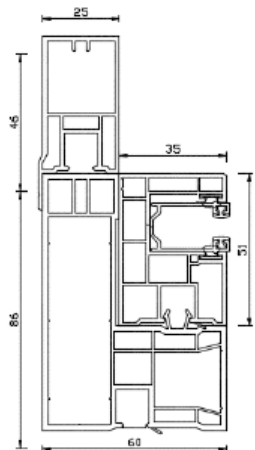

P) Variabel ab 25 mm

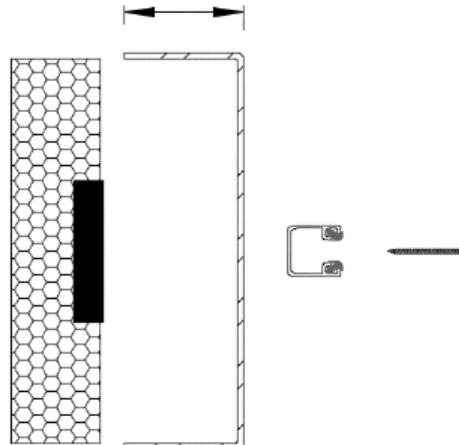

A-SW A1-A5



Spannwinkel	
Typ	Z- Maß
A1/25x30	27-53mm
A2/25x30 *	53-78mm
A3/25x40	81-106mm
A4/25x40	109-134mm
A5/25x40	137-162mm

* Standard bei 140mm Schacht